

DT05

Track Dumpers



**WACKER
NEUSON**
all it takes!



The space saving miracle

Wacker Neuson's track dumper DT05 can be maneuvered on any surface with centimeter-accuracy, thanks to its compact dimensions and precision control. It really comes into its own where space is very tight and agility is a must.

- The hydrostatic drive enables easy and comfortable operation.
- Powerful engines (gasoline or diesel); 2-stage speed adjustment.
- Robust crawler design guarantees long service life with low wear and tear.
- Optimal ratio between low net weight and maximum payload.
- Ultra-compact dimensions (66 cm), ideal for working in confined spaces and making its way through standard doors; high ground clearance. Optional high-tipping skip available.

DT05 Technical specifications

	front tip skip	high tip skip
Operating data		
Shipping weight - gasoline engine kg	420	475
Shipping weight SLE kg	500	
Shipping weight - diesel engine kg	465	520
Shipping weight SLE kg	545	
Payload max. kg	500	400
Skip capacity level I	273	170
Skip capacity heaped I	313	210
L x W x H mm	1,630 x 660 x 1,185	1,510 x 660 x 1,185
Engine / Motor		
Engine performance - gasoline engine kW	4.5	4.5
Engine performance - diesel engine kW	4.9	4.9
at rpm rpm	3,600	3,600
Travel speed gasoline engine km/h	3.9	3.9
Travel speed diesel engine km/h	4	4
Gradeability %	36	36
Fuel tank capacity Benzin l	3.6	3.6

DT05 Dimensions

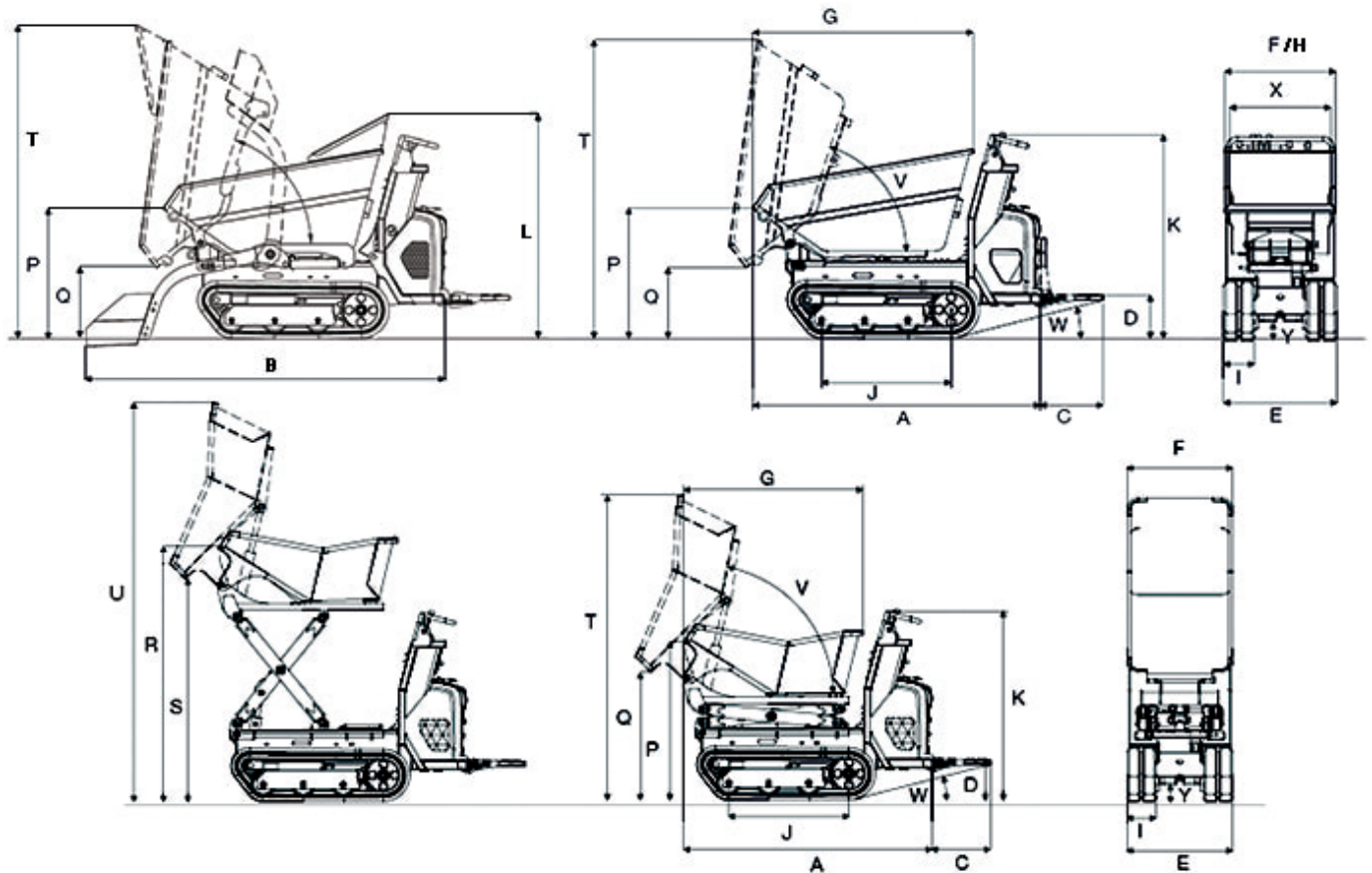

		Front tip skip	High tip skip
A	Length (without running board)	1,670 mm	1,550 mm
B	Length with self-loading equipment (without running board)	2,149 mm	
C	Length of running board	365 mm	387 mm
D	Height over running board	252 mm	252 mm
E	Width undercarriage	660 mm	660 mm
X	Width control console	589 mm	660 mm
F	Skip width	660 mm	660 mm
G	Length	1,280 mm	1,120 mm
H	Width with self-loading equipment	700 mm	
I	Chain width track	180 mm	180 mm
J	Length track	753 mm	753 mm
K	Height over control console	1,185 mm	1,185 mm
L	Height over skip hand protector	1,310 mm	
P	Height of skip front edge	760 mm	993 mm
Q	Dump height max.	410 mm	1,397 mm
R	Height of skip front edge when raised		1,600 mm
S	Dump height max. of high-tipping skip when raised		1,397 mm
T	Height max., skip raised	1,735 mm	1,907 mm

U	Height max., high-tipping skip raised		2,500 mm
V	Dump angle skip dumping	72 °	77 °
W	Bucket rollback running board retraction	15 °	14 °
Y	Ground clearance	110 mm	110 mm

Please note: that product availability can vary from country to country. It is possible that information / products may not be available in your country. More detailed information on engine power can be found in the operator's manual; the stated power may vary due to specific operating conditions. Subject to alterations and errors excepted. Applicable also to illustrations.
 Copyright © 2020 Wacker Neuson SE.