

DT08

Track Dumpers



**WACKER
NEUSON**
all it takes!



The rental fleet pro

Wacker Neuson's track dumper DT08 can be maneuvered on any surface with centimeter-accuracy, thanks to its compact dimensions and precision control. Its 800 kg payload and width of only 79 cm make the DT08 the ideal addition to any rental fleet.

- The hydrostatic drive enables easy and comfortable operation; powerful engines (gasoline or diesel).
- Robust crawler design guarantees long service life with low wear and tear.
- Optimal ratio between low net weight and maximum payload.
- Compact dimensions (79 cm), ideal for working in confined spaces and making its way through standard doors; high ground clearance.
- The rubber track and the optimum weight distribution reduce the ground pressure and prevent damage to delicate surfaces. The tailor-made cooling system guarantees safe operation of the machine in high-temperature conditions.

DT08 Technical specifications

	Front tip skip	High tip skip
Operating data		
Shipping weight - gasoline engine kg	520	580
Shipping weight mit SLE kg	590	
Shipping weight - diesel engine kg	560	625
Shipping weight mit SLE kg	630	
Payload max. kg	800	500
Skip capacity level I	334	240
Skip capacity heaped* I	387	280
L x W x H * mm	1,660 x 790 x 1,203	1,545 x 790 x 1,240
Engine / Motor		
Engine performance - gasoline engine kW	6.7	6.7
Engine performance - diesel engine kW	6.8	6.8
at rpm rpm	3,600	3,600
Travel speed max. km/h	4	4
Gradeability %	36	36

* Model with front-tipping skip

DT08 Dimensions

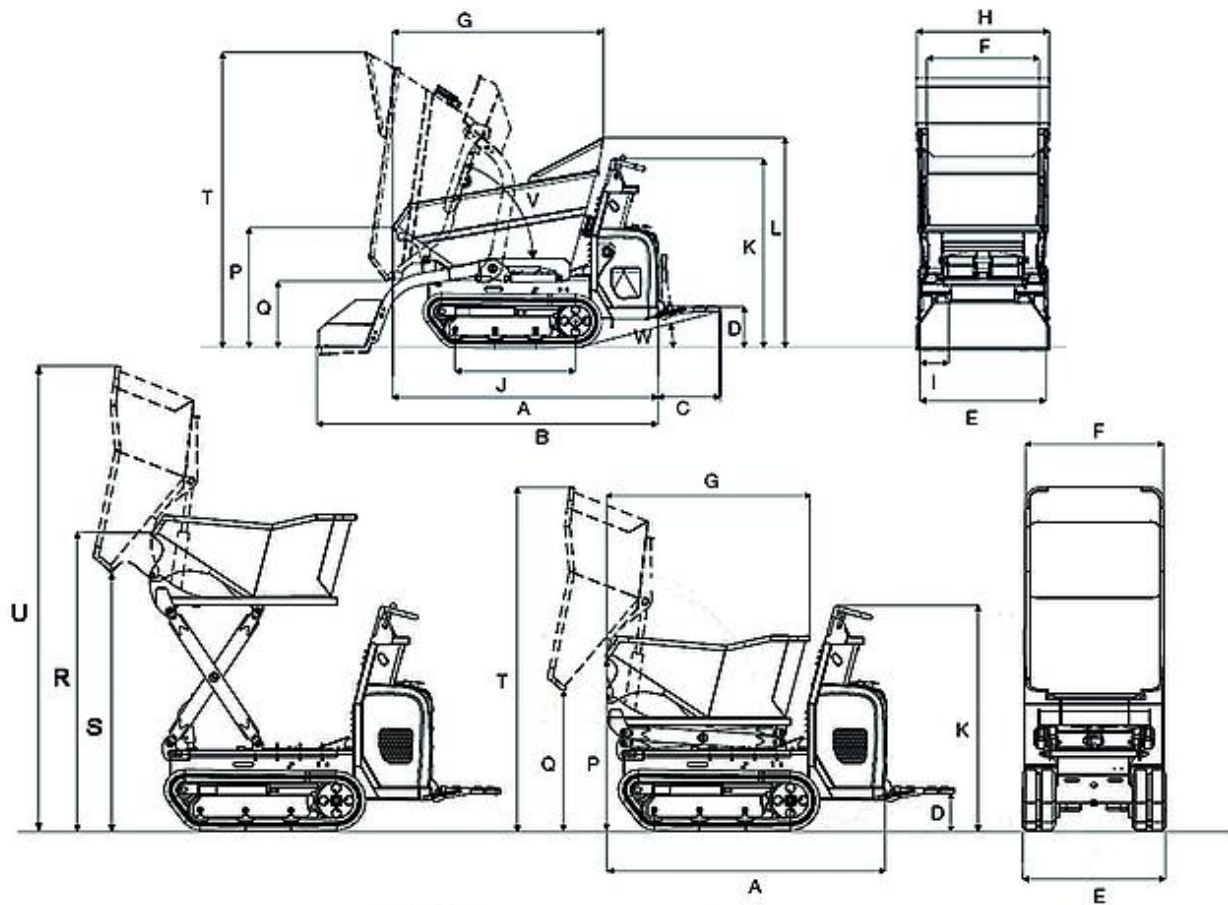

		Front tip skip	High tip skip
A	Length (without running board)	1,660 mm	1,545 mm
B	Length with self-loading equipment (without running board)	2,132 mm	
C	Length of running board	388 mm	387 mm
D	Height over running board	235 mm	234 mm
E	Width Undercarriage	790 mm	790 mm
F	Skip width	830 mm	764 mm
G	Skip length	1,320 mm	1,134 mm
H	Width with self-loading equipment	830 mm	
I	Chain width Track	180 mm	180 mm
J	Length Track	753 mm	753 mm
K	Height over control console	1,240 mm	1,240 mm
L	Height over skip hand protector	1,313 mm	
P	Height of skip front edge	750 mm	964 mm
Q	Dump height max.	420 mm	757 mm
R	Height of skip front edge when raised		1,646 mm
S	Dump height max. of high-tipping skip when raised		1,426 mm
T	Height Max., skip raised	1,845 mm	1,898 mm
U	Height Max., high-tipping skip raised		2,570 mm

V	Dump angle Skip dumping	72 °	82 °
W	Bucket rollback Running board retraction	14 °	13 °
Y	Ground clearance	110 mm	110 mm

Please note: that product availability can vary from country to country. It is possible that information / products may not be available in your country. More detailed information on engine power can be found in the operator's manual; the stated power may vary due to specific operating conditions. Subject to alterations and errors excepted. Applicable also to illustrations.

Copyright © 2020 Wacker Neuson SE.